

Model # 204-0029-01

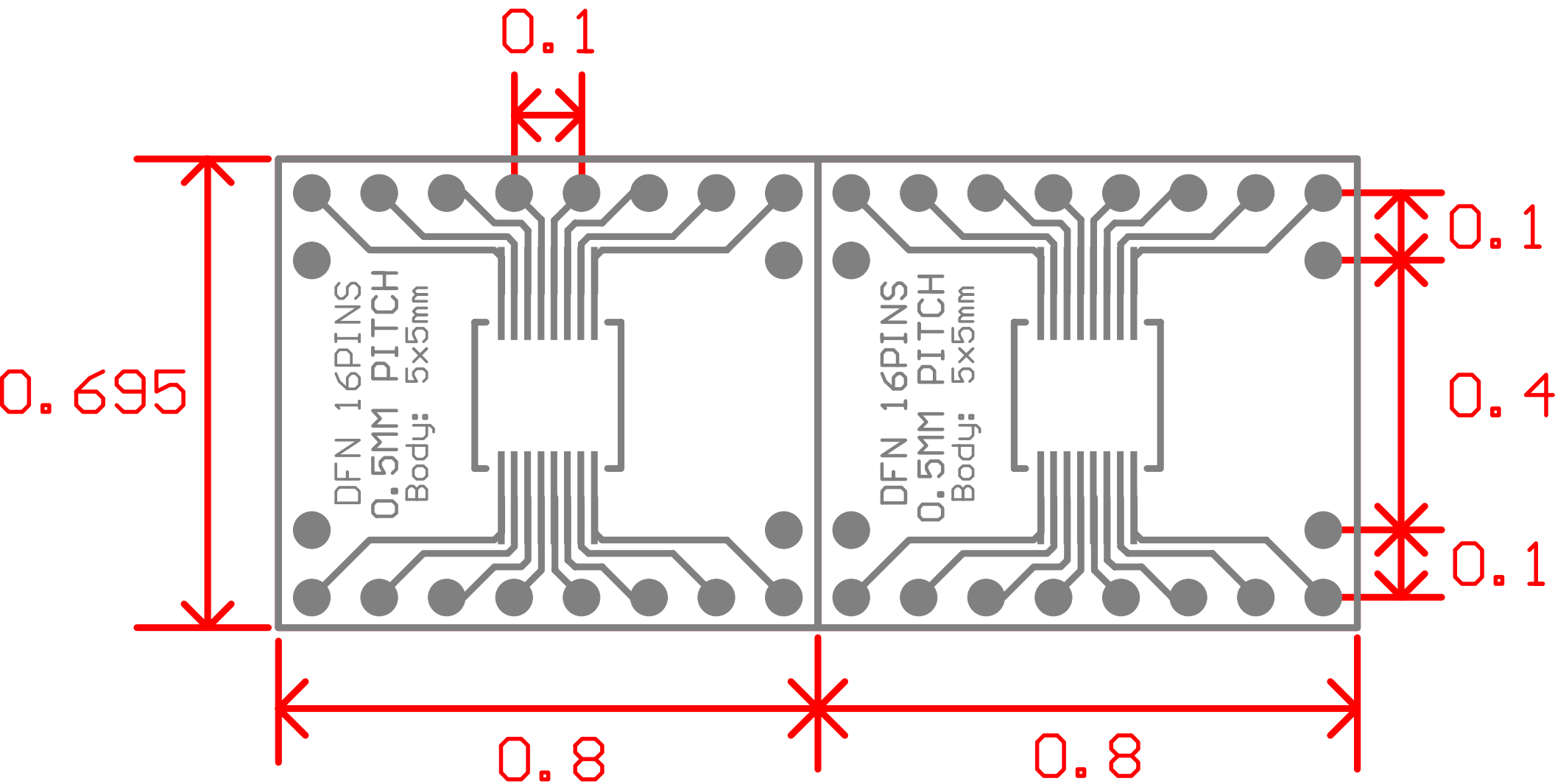

All through holes are 0.038
UNIT: Inch