

Model # 204-0023-01

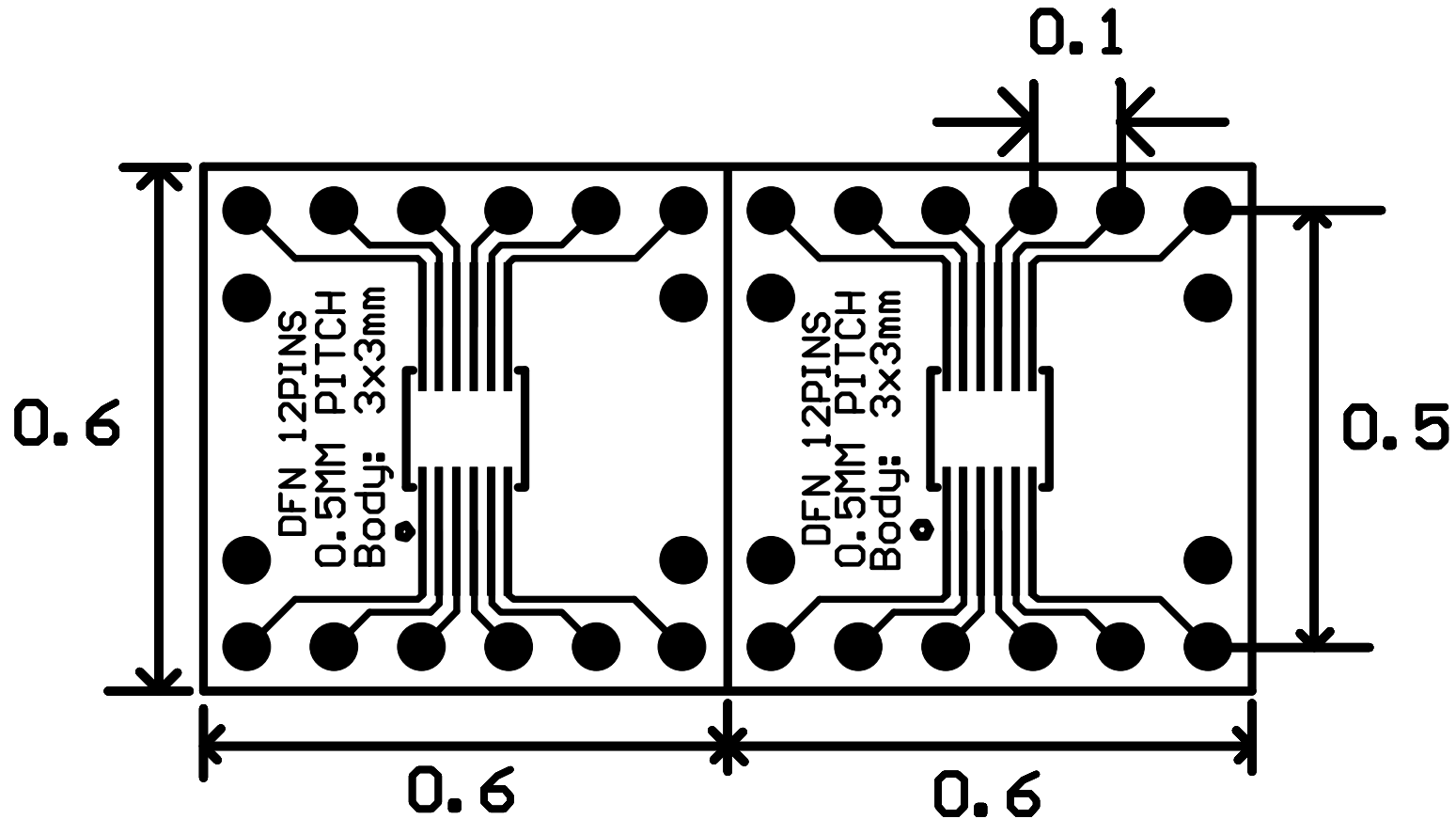

All through holes are 0.038
UNIT : INCH